

DVD

DVD

DVD

DVD

D

DVD

D

DVD

DVD

DVD

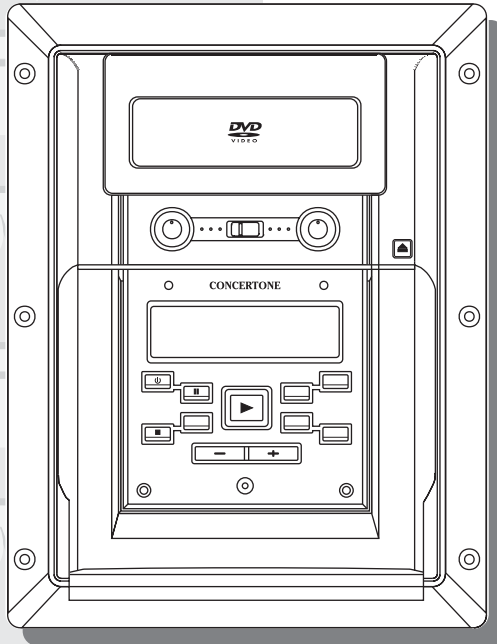

CONCERTONE™

OPERATING INSTRUCTIONS
DVD STEREO RADIO SYSTEM

SAFETY PRECAUTIONS & WARRANTY

WARRANTY

ONE (1) YEAR LIMITED WARRANTY

CONCERTONE warrants to the original retail purchaser of this radio that it or any part therein, under normal use and conditions, be proven defective in material or workmanship within 1 year from the date of original purchase, such defect/s will be repaired or replaced at **CONCERTONE'S** option without charge for parts and repair labor.

This warranty does not extend to the elimination of externally generated static or noise, to the correction of antenna generated noise or to the cost incurred to correct this noise. The warranty does not cover the removal/reinstallation of this radio or damage to any tapes, CD's speakers, accessories, or the vehicles electrical system.

This warranty does not cover the cabinet appearance or apply to the radio or any part of the radio which in the opinion of **CONCERTONE**, has been damaged through alterations, improper installation, mishandling, misuse, neglect, or accident. THE EXTENT OF **CONCERTONE'S** LIABILITY UNDER THIS WARRANTY IS LIMITED TO THE REPAIR OR REPLACEMENT PROVIDED ABOVE, AND IN NO EVENT, SHALL **CONCERTONE'S** LIABILITY EXCEED THE PURCHASE PRICE PAID BY THE ORIGINAL BUYER FOR THE RADIO.

This warranty extends only to the original purchaser of the radio and is not transferable.

Some states do not allow limitations on how long an implied warranty last, and some states do not allow the exclusion or limitation of incidental or consequential damages, so the above limitations or exclusion may not apply to you. This warranty gives you specific legal rights.

To obtain repair or replacement within the terms of this warranty, the radio is to be delivered with proof of purchase with a description of the defect/s, freight prepaid, to the original dealer



The lightning flash and arrowhead within the triangle is a warning sign alerting you of "dangerous voltage" inside the product.

WARNING

**RISK OF ELECTRIC SHOCK
DO NOT OPEN**

WARNING: TO REDUCE THE RISK OF ELECTRIC SHOCK, DO NOT REMOVE COVER (OR BACK) NO USER-SERVICEABLE PARTS INSIDE. REFER SERVICING TO QUALIFIED SERVICE PERSONNEL.



The exclamation point within the triangle is a warning sign alerting you of important instructions accompanying the product.

CAUTION: INVISIBLE LASER RADIATION WHEN OPEN AND INTERLOCKS DEFEATED. AVOID EXPOSURE TO BEAM.

ADVARSEL: USYNLIG LASERSTRÅLING VED ÅBNING NÅR SIKKERHEDSAFBRYDERE ER UDE FUNKTION UNDGÅ UDSÆTTELSE FOR STRÅLING.

VARO: AVATTAESSA JA SUOJALUKITUS OHITETAESSA OLET ALTITINA NÄKYMÄTTÖMÄLLE LASER-SÄTEILYLLE. ÄLÄ KATSO SÄTEESEEN!

WARNING: OSYNLIG LASERSTRÅLNING NÅR DENNA DEL ÄR ÖPPNAD OCH SPÄRREN ÄR URKOPPLAD BETRakta EJ STRÅLEN!

- THIS DEVICE COMPLIES WITH PART 15 OF THE FCC RULES. OPERATION IS SUBJECT TO THE FOLLOWING TWO CONDITIONS: (1) THIS DEVICE MAY NOT CAUSE HARMFUL INTERFERENCE, AND (2) THIS DEVICE MUST ACCEPT ANY INTERFERENCE RECEIVED, INCLUDING INTERFERENCE THAT MAY CAUSE UNDESIRABLE OPERATION.

- COMPLIES WITH DHHS RULES 21CFR SUBCHAPTER J APPLICABLE AT DATE OF MANUFACTURE.

WARNING: TO REDUCE THE RISK OF FIRE OR ELECTRIC SHOCK, DO NOT EXPOSE THIS APPLIANCE TO RAIN OR MOISTURE.

This product contains a low power laser device. To ensure continued safety, do not remove any covers or attempt to gain access to the inside of the product. Refer any servicing to qualified personnel.



TABLE OF CONTENTS

Safety Precautions & Warranty	1	Playing MP3 and Picture File Disc	20-21
Disc Formats	3	Playing a MP3 file disc	20
Before You Start	4	Playing a Picture file disc	21
Using the remote control	4	Playing a MP3/Picture file disc	21
Control Reference Guide	5-7	Radio Operation	22
Display Information	8	Tuning into a station manually	22
Installation	9	FM Stereo	22
Turning on the unit	9	Weak FM stations	22
Automatic turning off the unit (Sleep function)	9	To search for a station automatically	22
Adjusting the Sound	10-11	Presetting stations	22
Playing a Disc	12-14	Tuning into a preset station	22
Playing a Disc	12	TV Setup	23-24
Pausing playback (still mode)	12	NTSC CATV or NTSC AIR setting	23
Stopping playback	12	Automatically Preset the TV Stations	23
To skip to a different track	12	Add TV Channel or Delete TV Channel	24
Fast Forward/Fast Reverse	13	Add all TV Channel or Delete all TV Channel	24
Slow-motion play	13	Watching a Television	24
Skip (Forward/Reverse)	13	Customizing the Function Settings	25-29
Zooming into an image	13	Language setting	25
Angle selection	14	VIDEO setting	25-27
Audio selection	14	TV shape	25
Subtitle selection	14	Video output	26
Special Functions	15-17	Brightness	27
Display function	15	Edges	27
Locating a specific title	16	AUDIO setting	28
Locating a specific title/chapter/track	16	Digital Out	28
Locating a specific time	17	RATING setting	28-29
Angle setting	17	Factory set	28
Audio setting	17	Password/parental lock	29
Subtitle setting	17	Language Code List for Disc Language ..	30
CD / DVD programmable memory	18	Maintenance	31
DVD programmable memory	18	Cleaning Disc	31
Title/Chapter programmed playback	18	Cleaning the Unit	31
CD programmable memory	18	Important Notice	31
Track programmed playback	18	Specifications	32
Repeat Playback	19	System Connections.....	33
Repeating a title/chapter (DVD)	19		
Repeating a single track/whole disc (CD)	19		
Repeating a specific section (DVD)	19		

DISC FORMATS

The unit can playback.



DVDs
[8cm/12cm disc]



Audio CDs
[8cm/12cm disc]



Region Management Information

Region Management Information: This unit is designed and manufactured to respond to the Region Management Information that is encoded on DVD discs. If the Region number printed on the DVD disc does not correspond to the Region number of this unit, this unit cannot play that disc.







The region number of this unit is 1.

Disc Function or Operation that is Not Available

When the  symbol appears on the screen, it indicates that the function or operation attempted is not available at that time. This occurs because the DVD disc manufacturer determines the specific functions. Certain functions may not be available on some discs. Be sure to read the documentation provided with the DVD.

Icons Used on DVDs

Sample Icons

	1. English 2. French	—	Language selections for audio
	1. English 2. French	—	Language selections for subtitles
	16:9	—	Screen aspect ratio
	1 2	—	Multiple camera angles
		—	Region code indicator

Notes:

- This Unit supports 2-channel (L/R) audio and 5.1ch (Multi-channel) MPEG Audio 1/2 (only when the DIGITAL AUDIO OUT coaxial jack is used for connection). It does not support 7.1 channel MPEG Audio Version 2.0.
- When playing back a CD-G (Graphics) or CD EXTRA disc, the audio portion will be played, but the graphic images will not be shown.

Title, Chapter and Tracks

- DVDs are divided into “titles” and “chapters”. If the disc has more than one movie on it, each movie would be a separate “title”. “Chapters” are sections of titles.
- Audio CDs are divided into “tracks”. A “track” is usually one song on an Audio CD.

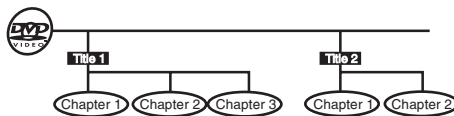

Note:

- Numbers identify each title, chapter, and track on a disc. Most discs have these numbers recorded on them, but some do not.

Notes on Unauthorized Discs

You may not be able to play back some DVD discs on this unit if they were purchased from outside your geographic area or made for business purposes.

BEFORE YOU START

USING THE REMOTE CONTROL CORRECTLY

- Point the Remote Control at the REMOTE SENSOR located on the unit.
- When there is a strong ambient light source, the performance of the infrared REMOTE SENSOR may be degraded, causing unreliable operation.
- The recommended effective distance for remote operation is about 5 meters (16 feet).

TO INSTALL BATTERIES

1. Open the battery door.

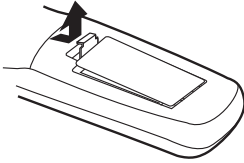

2. Insert two "AA" or UM-3 size batteries and replace the battery door.

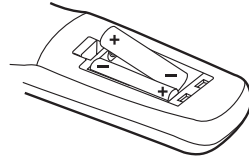

BATTERY REPLACEMENT

When batteries become weak, the operating distance of the Remote Control is greatly reduced and you will need to replace the batteries.

NOTE:

- If the Remote Control is not going to be used for a long time, remove the batteries to avoid damage caused by battery leakage corrosion.
- Do not mix old and new batteries. Do not mix ALKALINE, standard (CARBON-ZINC) or rechargeable (NICKEL-CADMIUM) batteries.
- **WARNING:** Do not dispose of batteries in fire, batteries may explode or leak.

CONTROL REFERENCE GUIDE

NAMES OF CONTROL - REMOTE CONTROL

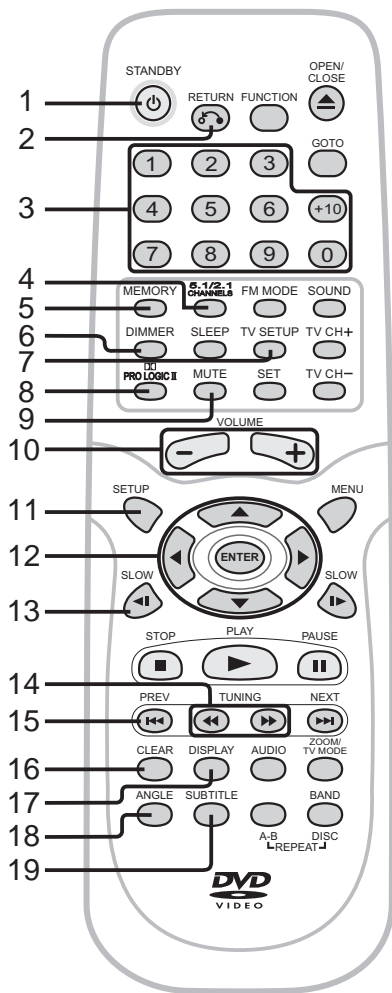

- 1) **STANDBY button**
Turn back to standby mode and turn on the unit.
- 2) **RETURN button**
Return to the normal operation after using the SETUP menu of a DVD.
- 3) **Number (0 - 9) and (+10) buttons**
Use when creating Tuner stations preset programs and select the preset station. Select a CD track directly. To select numbers over 9, press +10 button and then the second no. for example, to enter 18, press +10 and then 8.
- 4) **5.1 / 2.1 CHANNELS button**
Switch speaker output to 5.1 channel mode. (All speakers + subwoofer).
Switch speaker output to 2.1 channel. (Front left/right A speakers + left/right B speakers + subwoofer).
- 5) **MEMORY button**
Enter the number of a selected chapter or track.
Enter the number of a selected radio station.
- 6) **DIMMER button**
Adjust the brightness of the front panel display to the level you prefer.
- 7) **TV SET UP button**
Open and close TV Setup menu screen.
- 8) **PRO LOGIC II button**
In AV_IN mode, switches to Dolby Pro Logic mode for VHS tapes encoded with Dolby Pro Logic.
- 9) **MUTE button**
Press this button to mute the sound completely.
Press the button once again to restore the previous sound level, and cancel the mute.
- 10) **VOLUME (+/-) buttons**
Adjust the volume.
- 11) **SETUP button**
Open and close the SETUP menu screen of a DVD.
- 12) **CURSOR (▲, ▼, ◀, ▶) buttons**
Use to highlight selections on a menu screen and make adjust certain settings.
ENTER button
Confirm selections on a menu screen.
- 13) **◀ SLOW button**
Perform slow reverse playback of DVDs.
- 14) **◀◀ / ▶▶ buttons**
◀◀ : Fast reverse playback.
▶▶ : Fast forward playback.
TUNING (◀◀ / ▶▶) : Scan all available radio stations.
- 15) **◀◀◀ PREV button**
Move reverse through titles, chapters or tracks on a disc.
Tune to the presetted stations.
- 16) **CLEAR button**
Clear input selections and cancel certain playback functions.
- 17) **DISPLAY button**
Change disc status information displayed on the screen.
- 18) **ANGLE button**
Switch the camera angle of the video presentation when scenes with multiple camera angles are recorded on a DVD.
- 19) **SUBTITLE button**
Select one of the subtitle languages programmed on a DVD.

(Continued on next page)

CONTROL REFERENCE GUIDE

NAMES OF CONTROL - REMOTE CONTROL

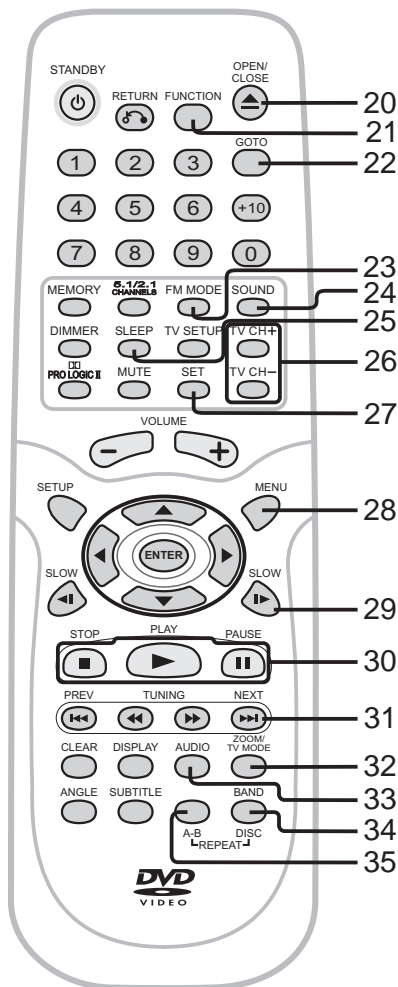

- 20) **▲ OPEN / CLOSE button**
Use to open or close the disc door.
- 21) **FUNCTION button**
Select the source.
- 22) **GOTO button**
Skip directly to a specific location on a DVD disc.
- 23) **FM MODE button**
Set FM MODE to FM STEREO for FM stereo sound or to FM MONO for mono sound.
- 24) **SOUND button**
Selects sound tone control for adjustment with the cursor buttons.
- 25) **SLEEP button**
When the sleep timer is used, the power is automatically turned off after the specified time passes.
- 26) **TV CH+/CH- buttons**
Select the desired channel of TV.
TV Setup menu screen and make adjust certain settings.
- 27) **SET button**
TV Setup menu screen.
- 28) **MENU button**
Open and close DVD's menu.
- 29) **SLOW ►► button**
Perform slow forward playback of DVDs.
- 30) **■ STOP button**
Stop playing a disc.
►►►► button
Press to start or resume playback a disc.
|| PAUSE button
Pause playback, frame advance.
- 31) **NEXT ►►►► button**
Move forward through titles, chapters or tracks on a disc.
Tune to the presetted radio stations.
- 32) **ZOOM button**
Zoom into an image of a DVD
TV MODE button
In stop mode, select whether to output the video signal. TV shows "AUTO" which means output signal depends on DVD disc (either NTSC or PAL). TV shows "PAL" or "NTSC" which means output signal fixed to PAL or NTSC.
- 33) **AUDIO button**
Select one of the audio soundtracks programmed on a DVD or selects the audio output mode on a AUDIO CD.
- 34) **BAND/REPEAT-DISC button**
Select AM(MW) or FM.
Repeat chapter or title of a DVD.
Repeat single track or whole CD.
- 35) **REPEAT A - B button**
Perform point-to-point repeat playback on a DVD or CD.

CONTROL REFERENCE GUIDE

NAMES OF UNIT

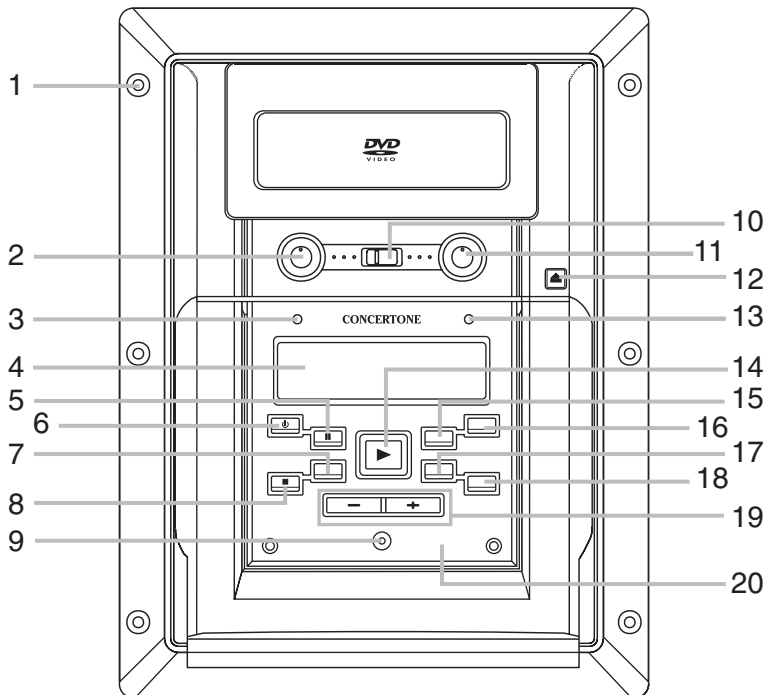

1. Mounting hole
2. BASS control knob
3. POWER indicator
4. DISPLAY window
5. PAUSE button
6. POWER ON/OFF button
7. FUNCTION (TUNER/TV/AUX/DVD) button
8. STOP/BAND button
9. REMOTE SENSOR
10. A/A+B/B SPEAKER selector switch

11. TREBLE control knob
12. CD DOOR OPEN/CLOSE button
13. PRO LOGIC II indicator
14. PLAY button
15. NEXT/CH+ button
16. TV SETUP/TUNING UP button
17. PREVIOUS/CH- button
18. TV SET/TUNING DOWN button
19. VOLUME controls
20. DISC door

DISPLAY INFORMATION

Display

STEREO indicator

Tune into a station. "STEREO" will appear when an FM broadcast is in stereo.

REPEAT ALL indicator

Displayed during for repeat playback.

REPEAT 1 playback indicator

Displayed during repeat playback.

TITLE indicator

When a DVD is loaded in the Unit, this indicator appears along with the title number.

REPEAT A-B playback indicator

Displayed during repeat playback.

ANGLE indicator

Appears when multiple camera angles are recorded in the section of the DVD that is currently playing.

MEMORY indicator

Displayed during programmed playback.

CHAPTER / TRACK indicator

When a DVD is loaded in the Unit, this indicator appears along with the chapter number.

When an Audio CD is loaded in the Unit, this indicator appears along with the track number.

TOTAL indicator

Indicates the elapsed playback time of the disc. With some discs, this area also shows the total play time of the disc when playback is stopped.



OPERATION indicator

Indicates the operation status of the disc and Unit.

DOLBY DIGITAL indicator

Displays while Dolby Digital sound processing is being performed or when the loaded disc contains Dolby Digital sound.

Display Examples

The displays information shown below on the screen and display depending on the operation status.

	Screen	Display	Remarks
If no disc is loaded when the Main Unit is switched on.	No Disc	NO DISC	"NO DISC" appears when the tray is closed and: 1) There is no disc in the tray. 2) The disc type is not playable in this unit. 3) The disc is not loaded correctly (upside-down, etc.)
Door open	▲	OPEN	
Door close		CLOSE	
Loading	⌚ Loading...	LOADING	
Stopped	■ Stop		The display changes to show other indicators (total time, etc.)
Playing	▶ Play		
Paused	⏸ Pause		Freezes the image on the screen or pauses audio playback.
Fast forward	⏩ x 2		The display changes to show other indicators (total time, etc.)
Fast reverse	⏪ x 2		
Slow	⏴ / ⏵ x 1/2		Does not function for Audio CDs.
Repeat A - B	REP A- REP A-B	A-B	Repeat a specific section.
	⊘		The operation is not permitted by the unit or the disc.

Region (Local) Number Error Indicator

If the region (local) number of the disc that you attempt to play differs from the region number of the Unit, "Invalid Region" appears on the screen. (The disc cannot be played).

INSTALLATION

Turning on the Unit and TV

1. Press the **POWER ON/OFF** button, the POWER indicator will turn off, or
2. Press the **⏻ STANDBY** button on the remote control.
3. Turn on the TV by pressing its **POWER** button.
4. Select the channel on your TV corresponding to the VIDEO IN jack that the Unit is connected.
5. Press the **FUNCTION** button to select the desired function.
 - If you have connected the Unit successfully and the **FUNCTION** select to DVD, the DVD logo (start-up picture) will appear on your TV screen.



Automatic turning off the unit (SLEEP function)

This function allows for selecting the time for automatically turning off the unit. (for a maximum period of 240 minutes).

1. Press the **SLEEP** button on the remote control until the desired for turning off appears on the display (SLEEP 240....210....180....150....120....90....60....30....25....20....15....10....5....OFF).
2. The unit will automatically turn off once the selected turning off time reaches "0".

ADJUSTING THE SOUND

To adjust the surround sound balance while Dolby Digital and Dolby Pro Logic II decoding is in effect

Use the remote control to make the following changes to speaker balance:

Front Speaker A (left)

- Press the **SOUND** button repeatedly to display LEFT, then press the **▼** or **▲** **CURSOR** button to adjust the sound level. It will show on the display of the Unit.

Front Speaker A (right)

- Press the **SOUND** button repeatedly to display RIGHT, then press the **▼** or **▲** **CURSOR** button to adjust the sound level. It will show on the display of the Unit.

Center Speaker

- Press the **SOUND** button repeatedly to display CENTRE, then press the **▼** or **▲** **CURSOR** button to adjust the sound level. It will show on the display of the Unit.

Rear Speaker A (left)

- Press the **SOUND** button repeatedly to display REAR L, then press the **▼** or **▲** **CURSOR** button to adjust the sound level. It will show on the display of the Unit.

Rear Speaker A (right)

- Press the **SOUND** button repeatedly to display REAR R, then press the **▼** or **▲** **CURSOR** button to adjust the sound level. It will show on the display of the Unit.

Subwoofer 1 & 2

- Press the **SOUND** button repeatedly to display WOOFER, then press the **▼** or **▲** **CURSOR** button to adjust the sound level. It will show on the display of the Unit.

Note :

- If you do not press any button within a few seconds, the display will return to normal.

To adjust the sound quality

Press the **SOUND** button repeatedly to select an equalization mode (**BASS** and **TREBLE**). Press the **▼** or **▲** **CURSOR** button to adjust the sound level.

BASS : the low range of sounds

TREBLE : the high range of sounds

Bass and treble control the sound from the front left and right speakers.

Dolby Digital

Dolby Digital is a sound system developed by Dolby Laboratories Inc. that gives movie theatre ambience to audio output when the Unit is connected to a Dolby Digital 5.1 channel processor or amplifier.

This Unit automatically recognizes DVDs that have been recorded with Dolby Digital.

Not all Dolby Digital sources are recorded with 6 channels.

Some sources marked Dolby Digital may be recorded in Dolby Surround, a 2 channel system.

Look for this logo on your DVD Unit.



Dolby Pro Logic II creates five full-bandwidth output channels from two-channel sources.

This is done using an advanced, high-purity matrix surround decoder that extracts the spatial properties of the original recording without adding any new sounds or tonal colorations.



Movie Mode (MOVIE)

The Movie mode in Pro Logic II is very similar to that of the original Pro Logic decoder. The main difference is that it has stereo surround channels and no surround filter, unlike Pro Logic which has a mono surround channel and a 7 kHz surround filter. Movie mode is the standard required for all A/V systems. When an autosound unit has a video screen, it is also considered an A/V system. It can be called simply "Pro Logic II".

Music Mode (MUSIC)

The Music mode offers users some flexibility to control the end results to their own taste. Music mode should not be used with THX audio processing mode. Music mode is recommended as the standard mode for autosound music systems (without video), and is optional for A/V systems. It is recommended that Music mode be identified as the "Music" version of Pro Logic II, to distinguish it from the Movie mode.

(Continued to next page)

ADJUSTING THE SOUND

Pro Logic Emulation Mode (EMU)

The Pro Logic emulation mode offers users the same robust surround processing as original Pro Logic, in case the source content is not of optimum quality, or if there is a desire to hear the program more “as it used to be”. When this mode is used, it is called Pro Logic, as before. There is no “Pro Logic I” mode. The Pro Logic emulation mode is optional. Dolby does not require PLII products to use the original Pro Logic decoding algorithm. However, if the DSP contains the original Pro Logic code, and if the product maker would like to use it, this is quite acceptable and even encouraged. A product must not offer both original Pro Logic and the Pro Logic emulation mode.



Matrix Mode (MATRX)

The Matrix mode is the same as the Music mode except that the directional enhancement logic is turned off. It may be used to enhance mono signals by making them seem “larger”. The Matrix mode may also find use in auto systems, where the fluctuations from poor FM stereo reception can otherwise cause disturbing surround signals from a logic decoder. The ultimate “cure” for poor FM stereo reception may be simply to force the audio to mono.

Manufactured under license from Dolby Laboratories.

‘Dolby’, ‘Pro Logic’ and the double-D symbol  are trademarks of Dolby Laboratories.

To select the listening channel

1. When the disc is stopped, you can press the **5.1/2.1 CH** button on the remote control to select different speakers output status shown on below table.
2. At AUX IN function mode, you also can press the  **PRO LOGIC II** button repeatedly on the remote control to select  **PRO LOGIC II** (indicator on the front panel of display will illuminate).

Notes:

- The wording “2.1 CH” will be corresponded to the audio/sound output from Front Left and Front Right speakers plus the Subwoofer.
- **5.1/2.1 CH** button is no response to JPG CD-ROM or JPG/MP3 CD-ROM. Please select 5.1/2.1 CH output before putting such CD-ROM.
- Dolby Digital 5.1 CH will not be activated in PRO LOGIC II.

The following table show which speakers are working in the various modes.

FUNCTION	DISCS	5.1/2.1 CH Button	L/R SPEAKER (SMALL/LARGE)	SUB-WOOFER ON/OFF	Dolby Pro Logic II Selection				
					EMU	MATRIX	MUSIC	MOVIE	BY PASS
DVD MODE	DVD / CD	5.1 CH	SMALL	ON	5.1	5.1	5.1	5.1	5.1 or 2.1
			LARGE	ON	5.1	5.1	5.1	5.1	5.1 or 2
			---	OFF	5	5	5	5	5 or 2
		2.1 CH	SMALL	ON	2.1	2.1	2.1	2.1	2.1
			LARGE	ON	2	2	2	2	2
			---	OFF	2	2	2	2	2
	DVD	5.1 CH	---	ON	5.1	5.1	5.1	5.1	5.1
			---	OFF	5	5	5	5	5
			SMALL	ON	2.1	2.1	2.1	2.1	2.1
		2.1 CH	LARGE	ON	2	2	2	2	2
			---	OFF	2	2	2	2	2
			---	---	---	---	---	---	---
TUNER	---	---	---	---	---	---	---	---	
AUX IN	---	---	SMALL	ON	5.1	5.1	5.1	5.1	5.1
			LARGE	ON	5.1	5.1	5.1	5.1	5.1
			---	OFF	5	5	5	5	5

Dolby Pro Logic II not applied on Tuner and PCM DVD.



5.1 - Represents FRONT LEFT/RIGHT, REAR LEFT/RIGHT, CENTER speakers and SUBWOOFER

2.1 - Represents FRONT LEFT/RIGHT speakers and SUBWOOFER

5 - Represents FRONT LEFT/RIGHT, REAR LEFT/RIGHT and CENTER speakers

2 - Represents FRONT LEFT/RIGHT speakers

This owner's manual explains the basic instructions of this DVD Unit. Some DVD discs are produced in a manner that allows specific or limited operation during playback. As such, the DVD Unit may not respond to all operating commands. This is not a defect in the DVD Unit. Refer to the instruction notes of discs.

"" may appear on the TV screen during operation. A "" means that the desired operation is not permitted by the DVD Unit or the disc.

Playing a Disc

1. Press the **POWER ON/OFF** button on the unit or press the  **STANDBY** button on the remote control to turn on the Unit while the Unit is in standby mode, press the **FUNCTION** button to select DVD mode.

See **CUSTOMIZING THE FUNCTION SETTINGS** (page 26 to 33) before proceeding to step 2.

2. Press the  **OPEN / CLOSE** button. The disc tray opens.



3. Place the disc on the disc tray with the label side up.

4. Press the  **OPEN / CLOSE** button. The disc tray closes.



It takes a short while for your Unit to load the disc. After loading, for some discs, the Unit will automatically start playback of the disc.

5. Press the  **PLAY** button.



Notes:



- Use the  **OPEN / CLOSE** button on the front panel to open or close the disc tray. Do not push the disc tray or you may damage the Unit.
- Let the disc tray open completely before removing the disc. Press the  **OPEN / CLOSE** button to close the disc tray after you remove the disc.

Pausing playback (still mode)



Press the  **PAUSE** button. To resume normal playback, press the  **PLAY** button.

Stopping playback

Press the  **STOP** button at the location where you want to interrupt playback. To resume playback at the position where the disc was stopped, press the  **PLAY** button.

If you press the  **STOP** button twice, the Unit's memory will be cleared and pressing the  **PLAY** button will reset the disc to the beginning.



To skip to a different track



- Press the  **PREV** button on the remote once to skip to the start of the previous track.
- Press the  **NEXT** button on the remote to skip to the next track.
- For audio CD disc, use the number buttons (remote control only) to jump straight to that track number.









(continued on next page)

PLAYING A DISC

Fast Forward/Fast Reverse

1. Press the **TUNING**  or  **TUNING** button when a disc is playing.

- The disc begins fast scan at x2 speed.
- Four speeds are available. Each time **TUNING**  or  **TUNING** button is pressed, the speed of fast scan changes in the following sequence:

 x 2 \rightarrow  x 4 \rightarrow  x 8 \rightarrow  x 20 or \leftarrow  x 20 \leftarrow  x 8 \leftarrow  x 4 \leftarrow  x 2

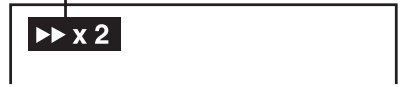

The speed of fast scan







2. Press the  **PLAY** button when you reach the desired point to resume playback at normal speed.

Slow-motion play



1. Press the **SLOW**  or  **SLOW** button in the play mode.

- Two speeds are available. Each time **SLOW**  or  **SLOW** button is pressed, the speed of slow-motion playback changes in the following sequence:

 1/2 \rightarrow  1/4 or \leftarrow  1/2 \leftarrow  1/4





2. Press the  **PLAY** button to return to the normal playback speed.

SKIP (Forward / Reverse)

While you are playing a disc, press the  **NEXT** button of the remote to move to the beginning of the next chapter or track. Press the  **PREV** button of the remote to move to the previous chapter or track and automatically start playing it.

Zooming into an image

While a disc is playing, press the **ZOOM/TV MODE** button.

- While an image is zoomed, you can use , ,  and  button to shift the view and display the part you want.
- To return to the normal view, press the **ZOOM/TV MODE** button until the “**Qoff**” symbol shows. The screen will return to normal.

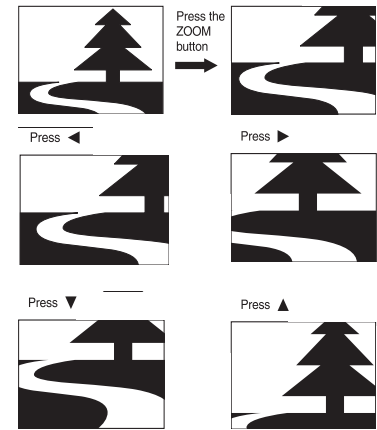

- When you reach the edge of the image, the display will not shift anymore in that direction.

(continued to next page)

Angle selection

Some DVDs contain scenes which have been shot from a number of different angles. For these discs, the same scene can be viewed from each of these different angles.

1. While you are playing a DVD with different angles recorded, press the **ANGLE** button to view the number of the current angle.
2. Press the **ANGLE** button repeatedly to change the scene to the next angle in those recorded.
 - About two seconds later, playback continues from the new angle you selected.
 - If no button is pressed within 10 seconds, playback continues without changing the current angle.

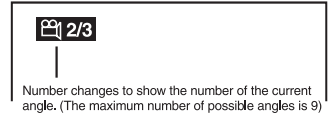

Sequence of angle shots (Example)

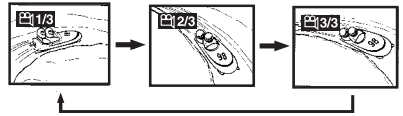

Notes:

- This function can only be used for discs on which scenes shot from multiple angles have been recorded.
- If only one angle is recorded, “ 1/1” is displayed.

Audio selection

On some discs, the sound is recorded in two or more formats. Follow the directions below to select the type of playback.

1. While a disc is playing, press the **AUDIO** button to show the current audio format number.
2. Press the **AUDIO** button repeatedly to select the desired audio format.

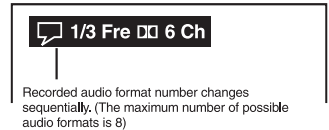





Notes :

- If only one audio format is recorded, the number does not change.
- About two seconds later, playback continues in the new audio format.

Subtitle selection

1. While a DVD is playing, press the **SUBTITLE** button to display the current language setting, as shown in the example below.
2. Press the **SUBTITLE** button repeatedly to select the desired subtitle language.

 1/3 Eng →  2/3 Spa →  3/3 Fre →  Off

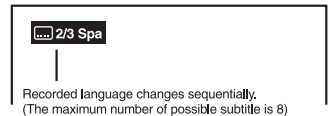

Notes :

- If only one language is recorded, the language does not change.
- About two seconds later, playback continues with the new subtitle you selected.
- The number of languages recorded differs depending on the disc.
- If no button is pressed within a few seconds, playback continues without changing the current subtitle.
- This function can only be used for discs on which subtitles have been recorded in multiple languages.
- On some DVDs, subtitles are activated from the main menu of the DVD. Press the **MENU** button to activate the main menu.

DISPLAY function

Using DISPLAY, you can check and change the current settings of the following items: ANGLE, AUDIO and SUBTITLE.

- While the disc is playing, press the **DISPLAY** button to display the screen shown below.
 - Elapsed time:** Elapsed time from the beginning of the chapter which is currently playing.
 - Remaining time:** Remaining time of the title which is currently playing.

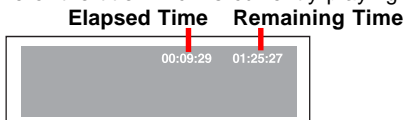

- Press the **DISPLAY** button twice to display the screen shown as below.
- Press the **ANGLE**, **AUDIO** and **SUBTITLE** button to change the selected item.

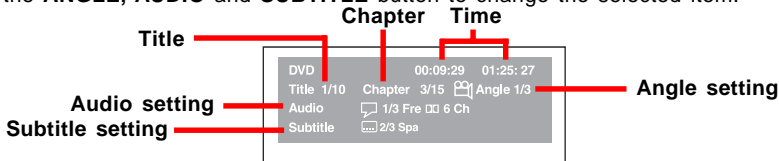

Title skip

- The number of the title currently playing and total titles of disc.
- Press the **GOTO** button to set your desired title, then press the **ENTER** button to confirm.

Chapter skip

- The number of the chapter currently playing and total chapters of the currently played title.
- Press the **GOTO** button to set your desired chapter, then press the **ENTER** button to confirm.

Time skip

- Elapsed time from the beginning of the currently playing chapter and the remaining time from the beginning of the currently playing title.
- Press the **GOTO** button to set your desired point to start playback, then press the **ENTER** button to confirm.

Angle setting

- The current angle is displayed. When a disc with only one angle is played back, "Angle 1/1" is displayed.
- Press the **ANGLE** button to select the desired angle.

Audio setting

- The type of audio currently selected is displayed.
- Press the **AUDIO** button to select your desired type of audio.

Subtitle setting

- The subtitle number and language currently selected is displayed. When a disc with only one subtitle is played back, "1/1 Eng" is displayed.
- Press the **SUBTITLE** button to select your desired language.

GOTO function

This function allows you to skip directly to any part of the disc while a disc is playing.

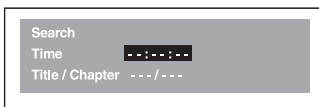

Note :

- After settings, press the **DISPLAY** button again to return to the normal screen.

(continued to next page)

Locating a specific title

If a DVD disc contains title numbers, you can locate a specific title by directly selecting a title number.

1. In stop mode, press the **GOTO** button.
2. Press **▼**, **◀** or **▶** button to highlight a specific field and press the corresponding number button(s) for the title you want.
3. Press the **ENTER** button to confirm. The Unit will start playback about 3 seconds later.

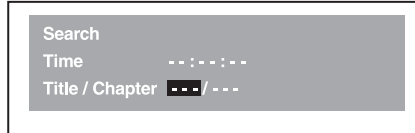

Note :

- Pressing the **CLEAR** button resets the title number.

Locating a specific title / chapter / track

If you know the title / chapter / track number you want to play, you can locate a specific title / chapter / track by directly selecting a title / chapter / track number.

1. Press the **GOTO** button to search your desired title / chapter / track.
2. Press **▼**, **◀** or **▶** button to highlight a title / chapter / track and press the corresponding number button(s) for the chapter you want.
3. Press the **ENTER** button to confirm. The Unit will start playback about 3 seconds later.

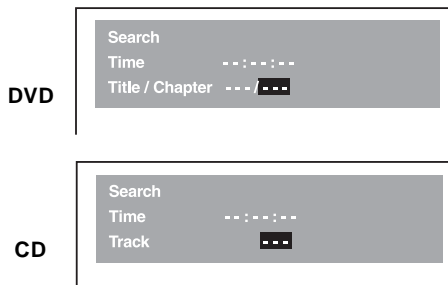

Note :

- Pressing the **CLEAR** button resets the title / chapter / track number.

(continued to next page)

Locating a specific time

You can move to a specific location by entering its corresponding time (hours, minutes, seconds)

1. Press the **GOTO** button.
2. Press **▲** or **▼** button to highlight time.

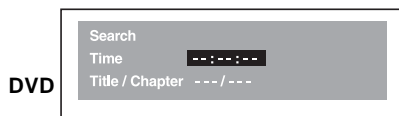

3. Press the corresponding number buttons for the setting point you want.
 - The first two numbers you entered represent hours.
 - The second two numbers you entered represent minutes.
 - The third two numbers you entered represent seconds.
4. Press the **ENTER** button to confirm. The Unit will start playback about 3 seconds later.

Notes :

- Some discs may not respond to this process.
- Some scenes may not be located as precisely as you specified.
- This method for accessing specific locations is available only within the current title of the DVD disc.
- You can move through the menu by pressing the **▲** and **▼** buttons.
- Pressing the **CLEAR** button resets the time.

Angle setting

1. Press the **DISPLAY** button twice. The FUNCTION menu is displayed on the screen and you can see how many angles are recorded on the disc.
2. Press the **ANGLE** button repeatedly to select your desired angle.
3. The Unit will change to your desired angle about 3 seconds later.

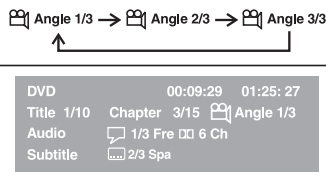

Audio setting

1. Press the **DISPLAY** button twice. The FUNCTION menu is displayed on the screen and you can see how many audio formats are recorded on the disc.
2. Press the **AUDIO** button repeatedly to select your desired type of audio.
3. The Unit will change to your desired type audio about 3 seconds later.

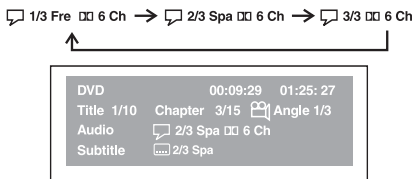

Subtitle setting

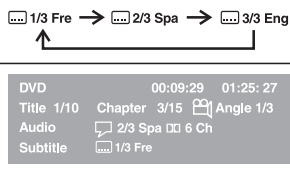

1. Press the **DISPLAY** button twice. The FUNCTION menu is displayed on the screen and you can see how many subtitle formats are recorded on the disc.
2. Press the **SUBTITLE** button repeatedly to select your desired language.
3. The Unit will change to your desired language about 3 seconds later.



Programmable memory

The two types of programmed playback provided by this Unit are title programmed playback and chapter programmed playback.

Title / Chapter programmed playback

1. Press the **MEMORY** button while the disc is stopped.
2. Enter the title numbers in . Use **◀** or **▶** button to move the highlight to chapter and enter the chapter numbers in .

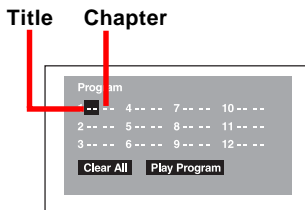

3. Use **◀**, **▶**, **▲** or **▼** button to move to the other field.
4. Repeat steps 2 to 3.
5. Press the **▶ PLAY** button to start the programmed playback.

Notes :

- If you press the **■ STOP** button twice time, the programmed selections will be cleared.
- If you press the **CLEAR** button while you are entering a title or chapter, the currently entered numbers will be erased and you can reset the numbers again.

Programmable memory

Track programmed playback

1. Press the **MEMORY** button while the disc is stopped.
2. Enter the track numbers in .

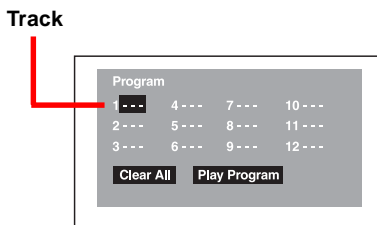

3. Use **◀**, **▶**, **▲** or **▼** button to other field.
4. Repeat steps 2 to 3.
5. Press the **▶ PLAY** button to start the programmed playback.

Notes :

- If you press the **CLEAR** button while you are entering a track, the currently entered numbers are erased and you can reset the numbers again.
- When the unit is playing at program memory mode, the "MEMORY" will display on display window.

You can play a specific title or chapter repeatedly.
(Title repeat, chapter repeat, A-B repeat)

Repeating a title

You can play the same title repeatedly.

1. While the disc is playing, press the **REPEAT DISC** button until the “ **Repeat Title** ” indicator displays on the screen. The current title is played repeatedly.



Repeating a chapter

You can play the same chapter repeatedly.

2. While the disc is playing, press the **REPEAT DISC** button until the “ **Repeat Chapter** ” indicator displays on the screen. The current chapter is played repeatedly.



To resume normal playback

3. While the disc is playing, press the **REPEAT DISC** button until the “ **Off** ” indicator displays on the screen.



You can play a single track and whole disc repeatedly.

Repeating a single track

You can play the same track repeatedly.

1. While the disc is playing, press the **REPEAT DISC** button until the “ **Repeat Single** ” indicator displays on the screen. The current track is played repeatedly.

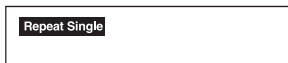

Repeating a whole disc

2. While the disc is playing, press the **REPEAT DISC** button until the “ **Repeat All** ” indicator displays on the screen. The whole disc is played repeatedly.

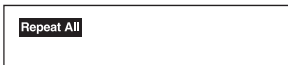

To resume normal playback

3. Press the **REPEAT DISC** button until the “ **Off** ” indicator displays on the screen.



Repeating a specific section

You can play a specific section repeatedly.

1. While the disc is playing, press the **REPEAT A-B** button at the beginning of the section (**Rep A -**) is displayed you want to play repeatedly.
2. Press the **REPEAT A-B** button again at the end of the section (**Rep A - B**) is displayed.
3. The Unit will immediately begin replaying your selection.



To resume normal playback

4. While the disc is playing, press the **REPEAT A-B** button until the “ **Off** ” indicator displays on the screen.



Notes :

- A-B repeat can only be used within the same title. If the start and end of the section to be repeated are in different titles, A-B repeat is cancelled.
- The A-B repeat function does not operate in scenes where different camera angles are recorded.

PLAYING MP3 AND PICTURE FILE DISC

This Unit will play MP3 and Picture files recorded on CD-R discs.

Playing a MP3 file disc

1. Press the **▲ OPEN /CLOSE** button, the disc tray opens.
2. Insert a MP3 file disc on the disc tray with the label side up.
3. Press the **▲ OPEN/CLOSE** button, the disc tray closes.
4. The Unit will take a short while to load the disc and automatically begin playback.

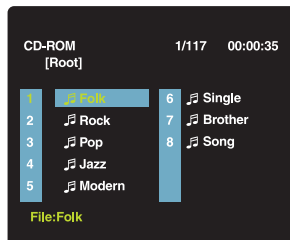

To pause playback

- Press the **|| PAUSE** button. To resume playback again, press the **▶ PLAY** button.

To stop playback

- Press the **■ STOP** button.

To skip to the next or previous file

- Press the **▶▶ NEXT** button on the remote control briefly while playing, to skip ahead to the beginning of the next file. Each time you press the button consecutively, the beginning of the next file is located and played back.
- Press the **◀◀ PREV** (Previous) button on the remote control briefly while playing, to skip back to the beginning of the previous file. Each time you press the button consecutively, the beginning of the previous files is located and played back.
- You also can press the **GOTO** button, set the track number you want and then press the **ENTER** button.

Note:

- You can not play in Fast reverse or Fast forward during MP3 playback.

On-screen display

Turn on your TV to view the on-screen display of MP3 files.

- Press the **▲, ▼, ◀** or **▶ CURSOR** button on the remote control to select the file you want to listen to, then press **ENTER** button and this selected file is located and played back.

Notes:

The ability of this Unit to read MP3 discs is dependent on the following:

- The Bit Rate must be within 64 - 256 kbps.
- The total number of files on the disc should not exceed 254.
- The maximum number of directories should not exceed 32.
- The maximum depth level of directories should not exceed 4.
- File names should be named using 12 or fewer letters and/or numbers, and must incorporate the "MP3" file extension. EXAMPLE: *****.MP3 where each * is a letter or number.
- Use only letters and / or numbers in file names. If you use special characters, the file and/or folder names may not be displayed correctly on the on-screen display.
- When recording on CD-R discs, use 74-minute (650MB) discs.
- The CD-R discs should be "finalized" in computer by "single session format".
- See your CD/MP3 creation software for details.

PLAYING MP3 AND PICTURE FILE DISC

Playing a Picture file disc

1. Press the **▲ OPEN /CLOSE** button, the disc tray opens.
2. Insert a Picture CD on the disc tray with the label side up.
3. Press the **▲ OPEN/CLOSE** button, the disc tray closes.
4. The unit will take a short while to load the disc.
5. Press the **▶ PLAY** button. The next picture will automatically display after 6 seconds.

Full-Screen
Review



Thumbnail
Review

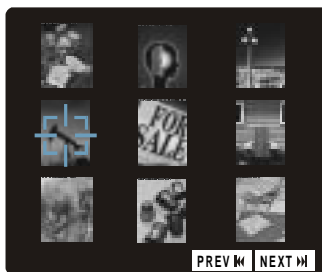

Notes:

- If you press the **MENU** button on the remote control in full-screen review, the Unit will display a menu of 9 thumbnail images.
- Use the **CURSOR** to highlight the **▶▶NEXT** or **◀◀PREV** in thumbnail screen and then press the **ENTER** button to review other images. If you want to review one image in full-screen, you can use the **CURSOR ▲, ▼, ◀ or ▶** button to highlight the image and then press the **ENTER** button to confirm. The image you selected will show on TV in Full-Screen and automatically display one by one again in about 6 seconds intervals.
- You can press the **PAUSE** button to interrupt playback, and press the **▶ PLAY** button to resume playback.
- You also can use **GOTO** function or use the numbered buttons to enter the number to quickly select any image.
- You can press the **ZOOM** button to enlarge the picture in 3 levels.
- Press the **ANGLE** button on the remote control to rotate the picture orientation by 90°.

Playing a MP3/Picture file disc

1. Press the **▲ OPEN /CLOSE** button, the disc tray opens.
2. Insert a MP3 files/Picture CD on the disc tray with the label side up.
3. Press the **▲ OPEN/CLOSE** button, the disc tray closes.
4. The unit will take a short while to load the disc.
5. Use **▲, ▼, ◀ or ▶** button to select MP3 or Picture CD, then press the **ENTER** button.

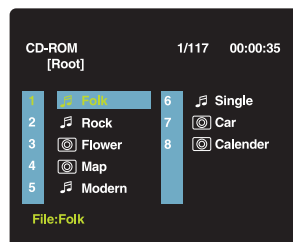

Note:

- The **SETUP** button does not work during MP3 or Picture Disc playback or stop.

RADIO OPERATION

Tuning into a station manually

1. Press the **FUNCTION** button until the frequency band appears on the display.
2. Press the **BAND** button to select the desired band.
3. Press the **◀◀ TUNING ▶▶** button to tune in the desired station.

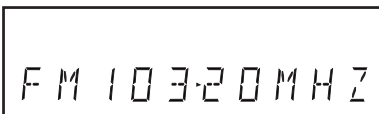

FM Stereo

- Press the **FM MODE** button on the remote until "STEREO" appears on the display.



Weak FM stations

- Press the **FM MODE** button on the remote until the "MONO" word appears on the display. Background noise will be reduced but the signal reproduced will be mono. To restore stereo reception, press the **FM MODE** button on the remote to select STEREO.
- Pull out the telescopic FM antenna. Adjust its position to obtain the best reception possible.



To search for a station automatically

- Hold down the **◀◀ TUNING ▶▶** buttons for 1 to 2 seconds, and a station is searched for automatically. After tuning in a station, the search stops.
- The search may not stop at a station with a very weak signal.

Presetting stations

You can tune into a stored station directly by entering the preset number.

20 stations on FM band can be preset.

20 stations on AM band can be preset.

1. Press the **FUNCTION** button until the frequency band appears on the display.
2. Press the **BAND** button on the remote to select the desired band.
3. Use the **◀◀ TUNING ▶▶** button to find your desired station.
4. Press the **MEMORY** button on the remote.
5. Press the **▶▶ NEXT** or **PREV ◀◀** button to select the preset number and press the **MEMORY** button on the remote to store the station.
6. Repeat steps 2-5 to store other stations.

Tuning into a preset station

1. Press the **FUNCTION** button until the frequency band appears on the display.
2. Press the **BAND** button to select the desired band.
- Press the **▶▶ PLAY** button and **▶▶ NEXT** or **PREV ◀◀** button on the remote to select the presetted station or use the numbered buttons to enter the number to select the presetted station.

Example: To select preset number 15, press the +10 and 5 buttons.

To select preset number 10, press the +10 and 0 buttons.

TV SETUP

- **Connecting a antenna or CATV cable to the TV RF IN terminal before TV SETUP.**
- **Use the remote control to access and adjust features as desired.**

1. Press the **FUNCTION** button until TV appears on the display.
2. Press the **TV SETUP** button to open the TV SETUP menu.
3. Press the **TV CH+** or **TV CH-** button to select the menu option, then press the **SET** button to enter the sub-menu.
4. Press the **TV CH+** or **TV CH-** button to select the sub-menu option, then press the **SET** button to confirm.
5. Press the **TV CH+** or **TV CH-** button to select YES or NO, then press the **SET** button to confirm.
6. Select Exit and press SET button to close the TV SETUP menu.

NTSC CATV or NTSC AIR setting

- Add channel :** Add the TV channel
Delete channel : Delete the TV channel
Auto scan : Automatically tunes in and presets receivable TV stations
Add all channel : Add all TV channel
Delete all channel : Delete all TV channel
Exit : To exit the TV SETUP menu

Automatically Preset the TV Stations

- All the TV stations in your area that can be received by the unit are automatically preset.
1. Press the **TV SETUP** button to open the TV SETUP menu.
 2. Press the **TV CH+** or **TV CH-** button to select NTSC CATV or NTSC AIR, then press the **SET** button to enter the sub-menu.
 3. Press the **TV CH+** or **TV CH-** button to select AUTO SCAN, then press the **SET** button to confirm.

Notes:

- Unused channels are automatically skipped.
- The screen show the first received channel when full auto channel preset is finished.

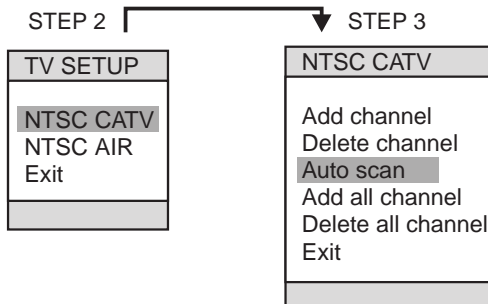

NOTE:

UHF/VHF WAVEBAND

This unit will search the VHF waveband before the UHF waveband. Therefore if you do not live in any area where VHF television signals are transmitted, it may take a little time before any stations are registered. Please note that up to 8 minutes may elapse before the search is completed.

(continued to next page)

TV SETUP

Add TV Channel or Delete TV Channel

1. Press number button on the remote control, you want to add or delete channel .
2. Press the **TV SETUP** button to open the TV SETUP menu.
3. Press the **TV CH+** or **TV CH-** button to select NTSC CATV or NTSC AIR, then press the **SET** button to enter the sub-menu.
4. Press the **TV CH+** or **TV CH-** button to select ADD CH or DELETE CH, then press the **SET** button to confirm.
5. For **DELETE CH**, press the **TV CH+** or **TV CH-** button to select YES or NO, then press the **SET** button to confirm.

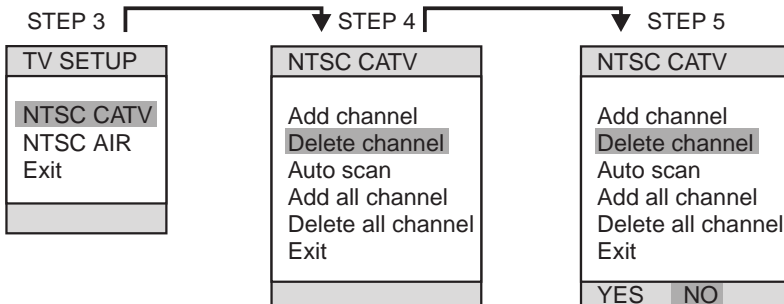

Add all TV Channel or Delete all TV Channel

1. Press the **TV SETUP** button to open the TV SETUP menu.
2. Press the **TV CH+** or **TV CH-** button to select NTSC CATV or NTSC AIR, then press the **SET** button to enter the sub-menu.
3. Press the **TV CH+** or **TV CH-** button to select ADD ALL CH or DEL ALL CH, then press **SET** button to confirm.
4. For **DEL ALL CH**, press the **TV CH+** or **TV CH-** button to select YES or NO, then press the **SET** button to confirm.

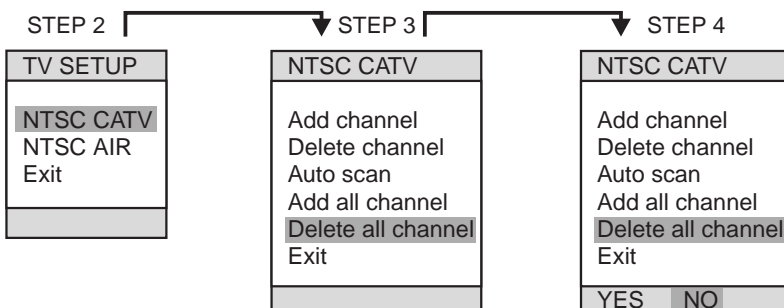

Watching a television

- You can view a television station after TV setup.
1. Press the **FUNCTION** button until TV appears on the display.
 2. Press the **TV CH+** or **TV CH-** button to select channel.
or
Press the **numbered buttons** of the remote to select channel.
For example: for channel 3, press 3
for channel 25, press 2 then 5.
- When a channel is selected the channel number is displayed in the top right corner of the screen.

CUSTOMIZING THE FUNCTION SETTINGS

LANGUAGE setting

1. Press the **FUNCTION** button until DVD appears on the display.
2. Press the **STOP** button so that no disc is playing.
3. Press the **SETUP** button.
4. Use ◀ or ▶ button to select the Language, then press the **ENTER** button.
5. Use ▲ or ▼ button to select English, then press the **ENTER** button. The screen will change to English Wordings immediately.
6. To exit the **FUNCTION SETUP MENU** and return to the normal screen, press the **RETURN** button.

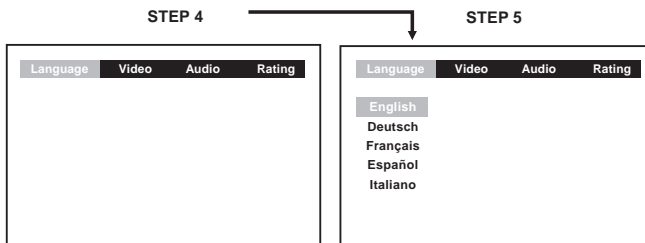

VIDEO setting

TV Shape

1. Press the **SETUP** button.
2. Use ◀ or ▶ button to select **Video**, then press the **ENTER** button.
3. Use ▲ or ▼ button to select TV Shape, then press the **ENTER** button.
4. Use ▲ or ▼ button to shift and select the TV type, then press the **ENTER** button.
5. To exit the **FUNCTION SETUP MENU** and return to the normal screen, press the **RETURN** button.

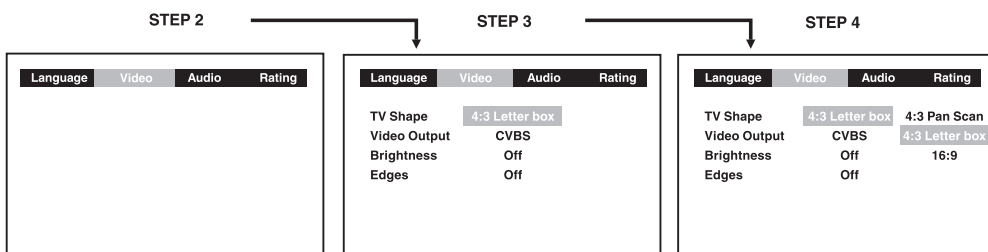

(continued to next page)

CUSTOMIZING THE FUNCTION SETTINGS

Cut off when a wide-screen video image is played.



4:3 Pan Scan

- When wide-screen video material is played, this mode clips the right and left sides of the image so that it can be viewed on a conventional screen.
- Some wide-screen DVDs that do not permit Pan Scan mode playback are automatically played in letterbox mode (black bands top and bottom).

4:3 Letter Box

- When wide-screen video material is played in this mode on a conventional screen, black bands appear at the top and bottom of the screen.

16:9 Wide-screen

- This is the correct mode for playing wide-screen videos on a wide-screen.

Notes :

- The displayable picture size is preset on the DVD disc. Therefore the playback picture of some DVD discs may not conform to the picture size you select.
- When you play DVD discs recorded in the 4:3 picture size only, the playback picture always appears in the 4:3 picture size regardless of the TV shape setting.

Video Output

1. Press the **SETUP** button.
2. Use ◀ or ▶ button to select **Video**, then press the **ENTER** button.
3. Use ▲ or ▼ button to select Video Output, then press the **ENTER** button.
4. Use ▲ or ▼ button to shift and select the signal, then press the **ENTER** button.
5. To exit the **FUNCTION SETUP MENU** and return to the normal screen, press the **RETURN** button.

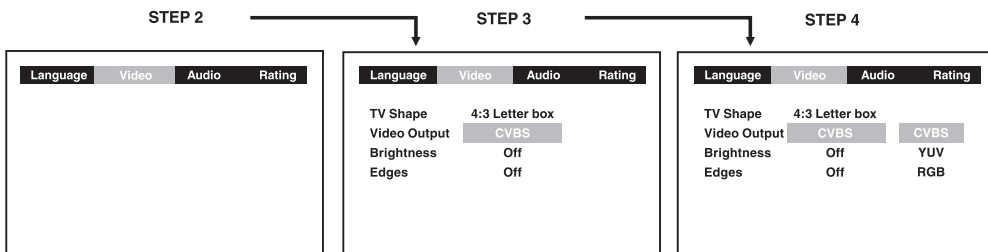

YUV : Corresponding to your TV which has a YUV input.

RGB : ONLY useful for use in Europe, and should not be selected.

Attention :

Always set Video Output in CVBS, otherwise, the picture on the TV may be distorted. If this occurs, and you cannot see the screen, follow these instructions:

1. Change **FUNCTION** to DVD mode.
2. Open the DVD door.
3. Press the **SETUP**, ▶, **ENTER**, ▼, **ENTER**, ▲, **ENTER** & **RETURN** buttons.

(continued to next page)

CUSTOMIZING THE FUNCTION SETTINGS

Brightness

1. Press the **SETUP** button.
2. Use ◀ or ▶ button to select **Video**, then press the **ENTER** button.
3. Use ▲ or ▼ button to select **Brightness**, and then press the **ENTER** button.
4. Use ▲ or ▼ button to shift and select the **Off/On**, then press the **ENTER** button.
5. If you want to exit the **SETUP MENU** and return to the normal screen, press the **RETURN** button.

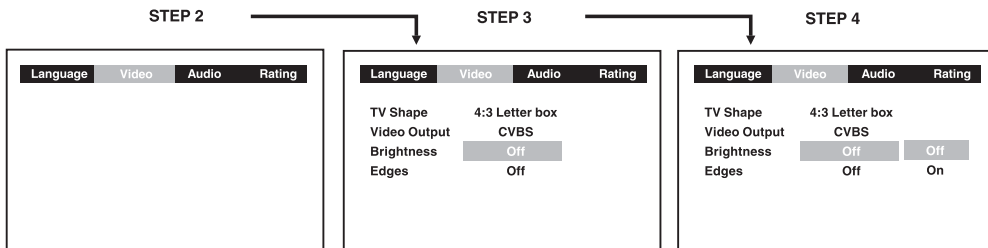

On : Picture will be brighter to clarify details.

Off : Picture will have deepened colors.

Edges

1. Press the **SETUP** button.
2. Use ◀ or ▶ button to select **Video**, then press the **ENTER** button.
3. Use ▲ or ▼ button to select **Edges**, and then press the **ENTER** button.
4. Use ▲ or ▼ button to shift and select the **Sharpen / Soften / Off**, then press the **ENTER** button.
5. If you want to exit the **SETUP MENU** and return to the normal screen, press the **RETURN** button.

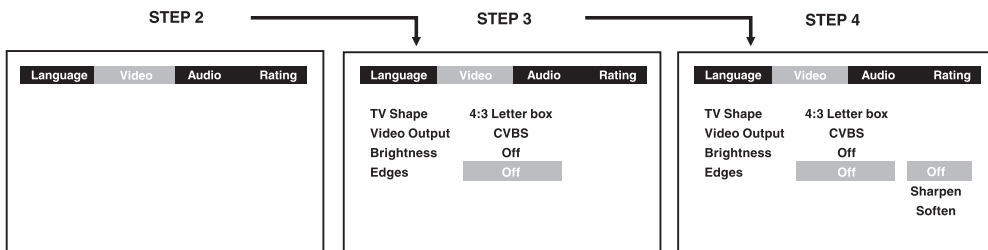

Sharpen : Fine detail will be easier to see.

Soften : Soft-focus effect.

Off : Picture will be returned to normal.

(continued to next page)

CUSTOMIZING THE FUNCTION SETTINGS

AUDIO setting

Digital Out

1. Press the **SETUP** button.
2. Use ◀ or ▶ button to select **Audio**, press the **ENTER** button.
3. Press the **ENTER** button repeatedly to select Digital Out type.
4. To exit the FUNCTION SETUP MENU and return to the normal screen, press the **RETURN** button.

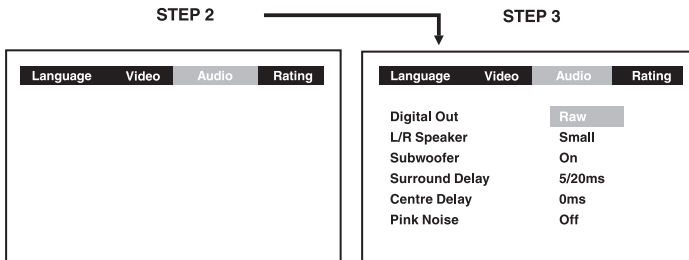

Raw : Does not have a Dolby Digital Decode.

PCM : Do have a Dolby Digital Decode.

RATING setting

Factory Set

If you want to return the initial language setting to the factory default, do the following:

1. Press the **SETUP** button.
2. Use ◀ or ▶ button to select the Rating, then press the **ENTER** button.
3. Use ▲ or ▼ button to shift and select the Factory Set, then press the **ENTER** button.
4. Use ▲ or ▼ button to shift and select Yes, then press the **ENTER** button.
5. To exit the FUNCTION SETUP MENU and return to the normal screen, press the **RETURN** button.

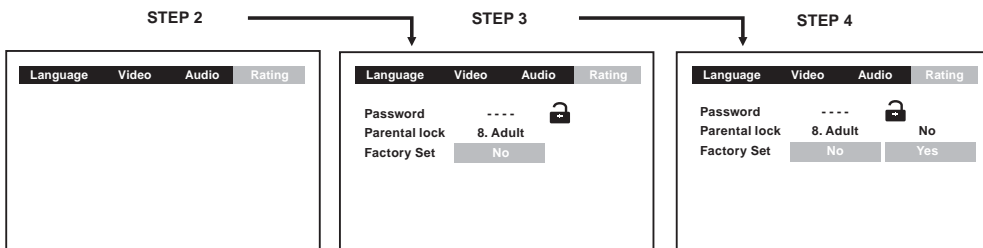

Note:

When you reset the Unit to the factory default, the Unit will take 3-5 seconds to reset.

(continued to next page)

CUSTOMIZING THE FUNCTION SETTINGS

Password/Parental lock

DVD discs equipped with the password function are rated according to their content. The contents allowed by a parental lock level and the way a DVD disc can be controlled may vary from disc to disc. For example, if the disc allowed, you could edit out violent scenes unsuitable for children and replace them with more suitable scenes, or you could lock out playback of the disc altogether.

1. Press the **SETUP** button.
2. Use ◀ or ▶ button to select Rating, press the **ENTER** button.
3. Use ▲ or ▼ button to select parental lock and then press the **ENTER** button repeatedly to set the parental lock level.
4. Use ▲ or ▼ button to shift and select Password, enter your 4-digit security code and then press the **ENTER** button.

If you make a mistake before pressing the **ENTER** button, press the **CLEAR** button and enter your 4-digit security code again.

You cannot play DVD discs rated higher than the level you selected unless you cancel the parental lock function.

The parental lock level is equivalent to the following ratings.

Level 1 : Kid Safe	Level 5 : PG_R
Level 2 : G	Level 6 : R
Level 3 : PG	Level 7 : NC_17
Level 4 : PG_13	Level 8 : Adult

5. To exit the FUNCTION SETUP MENU and return to the normal screen, press the **RETURN** button.



Indicates Parental lock is NOT active.



The Parental lock is active.

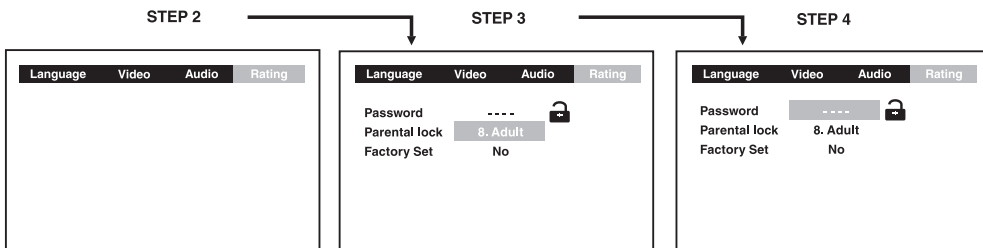

If you forget the password, you can erase your current password by pressing number 8 on the remote four times, then press the **ENTER** button to confirm the setting.

PASSWORD : 8 8 8 8

LANGUAGE CODE LIST FOR DISC LANGUAGE

Code	Language Name	Code	Language Name	Code	Language Name	Code	Language Name
AA	Afar	FY	Frisian	MG	Malagasy	SL	Slovenian
AB	Abkhazian	GA	Irish	MI	Maori	SM	Samoan
AF	Afrikaans	GB	Scots Gaelic	MK	Macedonian	SN	Shona
AM	Ameharic	GL	Galician	ML	Malayalam	SO	Somali
AR	Arabic	GN	Guarani	MN	Mongolian	SQ	Albanian
AS	Assamese	GU	Gujarati	MO	Moldavian	SR	Serbian
AY	Aymara	HA	Hausa	MR	Marathi	SS	Siswat
AZ	Azerbaijani	HI	Hindi	MS	Malay	ST	Sesotho
BA	Bashkir	HR	Croatian	MT	Maltese	SU	Sundanese
BE	Byelorussian	HU	Hungarian	MY	Burmese	SV	Swedish
BG	Bulgarian	HY	Armenian	NA	Nauru	SW	Swahili
BH	Bihari	IA	Interlingua	NE	Nepali	TA	Tamil
BI	Bislama	IE	Interlingue	NL	Dutch	TE	Telugu
BN	Bengali	IK	Inupiak	NO	Norwegian	TG	Tajik
	Bangla	IN	Indonesian	OC	Occitan	TH	Thai
BO	Tibetan	IS	Icelandic	OM	(Afan) Oromo	TI	Tigrinya
BR	Breton	IT	Italian	OR	Oriya	TK	Turkmen
CA	Catalan	IW	Hebrew	PA	Panjabi	TL	Tagalog
CO	Corsican	JA	Japanese	PL	Polish	TN	Setswana
CS	Czech	JI	Yiddish	PS	Pashto, Pushto	TO	Tonga
CY	Welsh	JW	Javanese	PT	Portuguese	TR	Turish
DA	Danish	KA	Georgian	QU	Quechua	TS	Tsonga
DE	German	KK	Kazakh	RM	Rhaeto-	TT	Tatar
DZ	Bhutani	KL	Greenlandic		Romance	TW	Twi
EL	Greek	KM	Cambodian	RN	Kirundi	UK	Ukrainian
EN	English	KN	Kannada	RO	Romanian	UR	Urdu
EO	Esperanto	KO	Korean	RU	Russian	UZ	Uzbek
ES	Spanish	KS	Kashmiri	RW	Kinyarwanda	VI	Vietnamese
ET	Estonian	KU	Kurdish	SA	Sanskrit	VO	Volapük
EU	Basque	KY	Kirghiz	SD	Sindhi	WO	Wolof
FA	Persian	LA	Latin	SG	Sangho	XH	Xhosa
FI	Finnish	LN	Lingala	SH	Serbo-	YO	Yoruba
FJ	Fiji	LO	Laothian		Croatian	ZH	Chinese
FO	Faroese	LT	Lithuanian	SI	Singhalese	ZU	Zulu
FR	French	LV	Latvian, Lettish	SK	Slovak		

MAINTENANCE

CLEAN DISC

If the DISC skips or will not play, the disc may need cleaning. Before playing, wipe the disc from the centre out with a cleaning cloth. After playing, store the disc in its case.



CLEANING THE UNIT

Do not use volatile chemicals on the unit. Clean by lightly wiping with a soft cloth.

IMPORTANT NOTICE:

- If an abnormal display indication or an operating problem occurs, turn off power. Wait at least 5 seconds, then turn on power.
- Before transporting the unit, remove the disc from the CD tray.

SPECIFICATIONS

TUNER SECTION

Frequency range	FM 87.5 -108 MHz AM 530 - 1,710 kHz (USA and Canada)
Antenna	External 75 ohm automotive type antenna

AMPLIFIER SECTION

Power output 10% T.H.D.	(A) 20W x 2 (Subwoofer) + 10W x 4 (B) 10W x 2
Power requirements	10/16 Volts DC

COMPACT DISC PLAYER SECTION

Frequency Response	40 - 20,000 Hz
Signal to noise ratio	60 dB
Dynamic Range	70 dB
Total harmonic Distortion	0.5% (Normal) T.H.D.
Separation	40 dB (at 1 kHz)

GENERAL (Tuner/CD Player)

Installation size:	Approx: 8-1/4" (W) x 6-1/2" (D) x 10-3/4" (H) (Inch)
Weight:	Approx: 6.3 Lbs.

Specifications and external appearance are subject to change without advance notice due to continuous product improvement.

SYSTEM CONNECTIONS

CONNECTION DIAGRAM

Make correct connections as illustrated in the connection diagram.

- 1** From TV Antenna
- 2** From Radio Antenna
- 3** From **B** Video Out
- 4** From **A** Video Out
- 5** From Other AUX input
- 6** From Remote input

SPEAKER CONNECTIONS

Be sure to connect stripe (-) and plain to plain (+) when hooking up speaker wires. This is to prevent any 'phasing' problems.

Notes:

- Use speakers with an impedance of 4 to 8 ohms, and with adequate power handling capacities. Otherwise, speaker may be damaged.
- DO NOT connect speakers in parallel. DO NOT connect the terminals of speaker system to the vehicle chassis.

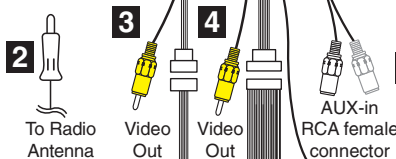
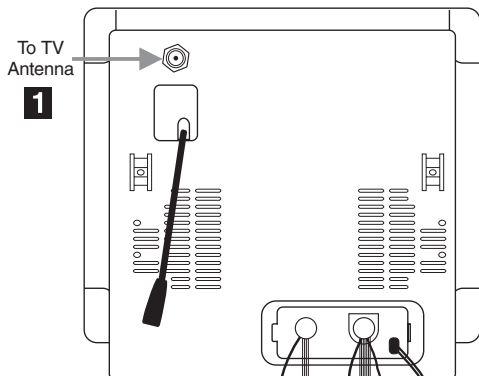

White wire to Remote In
Black wire to Ground
Red wire to VCC+

FUSE REPLACEMENT
The fuse is in the Fuse Filter Box. Replace with 15 Amp ATC Fuse.

Black wire To Grounded metal part of vehicle
Yellow wire To constant +12 volt source

SUBWOOFER CONNECTION

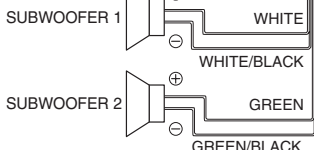

SPEAKERS CONNECTION

LEFT SPEAKER

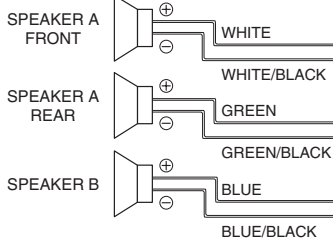

RIGHT SPEAKER

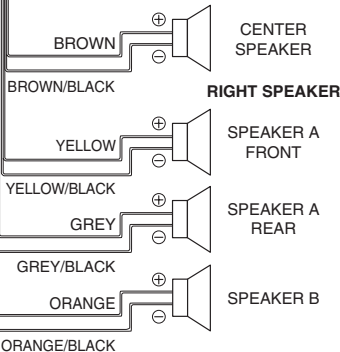

Caution:

Never ground or use the \ominus speaker wires in common with any other other wire. When replacing the fuse, be sure to use 15 Amp ATC fuse. Use of a fuse of higher amperage may cause serious damage to the unit.